

ADRET

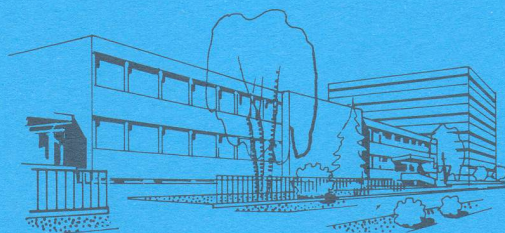

CALIBRATION

MAINTENANCE

ADRET
Schlumberger

12, avenue Vladimir Komarov • B.P. 33 78192 Trappes Cédex • France • Tél. 30.51.29.72
Telefax 30.51.00.74 • Télex ADREL 697821 F • Siret 679805077-00048 • CCP Paris 21 797 04

The tests described in the following pages will assure the user that the instrument corresponds to the technical characteristics stated in chapter II. These tests can be made as input inspection, periodical checking of the performances, or control of the characteristics following repairs made on the instrument.

INSTRUMENTS REQUIRED FOR THE TESTS

TYPE OF INSTRUMENT	REFERENCE	SPECIFICATIONS
Alternostat		0 V to 260 V , 200 W.
Multimeter	FLUKE 8000A	DC/AC , $\pm 1\%$ accuracy.
Oscilloscope	H.P. 180C + 1808A + 1820C	75 MHz bandwidth
Frequencymeter	SCHLUMBERGER FH 2523	10 Hz to 500 MHz , 9 digits.
RF voltmeter	H.P. 3406A	10 kHz to 1.2 GHz , $\pm 3\%$ accuracy.
Milliwattmeter	WANDEL & GOLTERMANN	10 kHz to 300 MHz ± 0.015 dB accuracy
Phasemeter	DRANETZ 305-PA-3002	2 Hz to 700 kHz , $\pm 0.1^\circ$ accuracy.
Spectrum analyzer (panoramic)	H.P. 180C + 8558B	0.1 MHz to 1.5 GHz , 70 dB dynamic range.
Spectrum analyzer (high resolution)	ADRET 6100 + 6303 + 6503	10 Hz to 110 MHz , 120 dB dynamic range.
X-Y recorder	H.P. 7041A	76 cm/s speed
Frequency Standard	ADRET 4101	Standard Receiver , $\pm 5 \cdot 10^{-10}/24$ h stability.
Frequency Error Multiplier	ADRET 4110	10^{-8} to 10^{-12} resolution
DC Source	ADRET 102	$\pm 5 \cdot 10^{-5}$ accuracy , 50 mA output current.

N° d'ESSAI appareils utilisés	CONDITIONS	SANCTIONS
<p>1</p> <p>2</p> <p>115 V - 230 V 45 Hz to 450 Hz power supply Alternostat Multimeter</p>	<p>VISUAL CONTROL</p> <p>Check the external aspect of the instrument and make sure that protection fuses (F1) and (F2) have a 250 mA value.</p> <p>AC LINE REGULATION</p> <p>Feed the instrument with a 45 Hz/450 Hz power supply and an alternostat as shown in figure VII-1.</p> <div data-bbox="450 741 1034 1061" data-label="Diagram"> </div> <p>Figure VII-1 AC LINE REGULATION</p> <p>a) Make the supply frequency vary from 45 Hz to 450 Hz successively on the 115 V and 230 V mains voltages.</p> <p>Measure the available voltages on socket (S01) (see figure VII-2) on the rear panel :</p> <ul style="list-style-type: none"> + 12 V with regard to ground - 12 V with regard to ground + 6 V with regard to ground. <p>b) Repeat the preceding test making the voltage vary from $\pm 10 \%$ through the alternostat successively on the 115 V and 230 V ranges.</p> <div data-bbox="450 1626 1034 1939" data-label="Diagram"> </div> <p>Figure VII-2 SOCKET (S01)</p>	<p>Accuracy :</p> <ul style="list-style-type: none"> ± 100 mV ± 100 mV ± 150 mV <p>The + 12 V, - 12 V and + 6 V voltages must remain identical within ± 1 mV.</p>

N° d'ESSAI appareils utilisés	CONDITIONS	SANCTIONS
<p>3</p> <p>AC power supply Alternostat 250 Hz low-pass filter Oscilloscope</p>	<p>c) Using the multimeter, measure the current absorbed by the instrument on the two mains voltages. Apply the formula : $P = U.I$ giving the apparent power consumed.</p> <p>RESIDUAL LF SIGNAL</p> <p>The instrument being powered at a 50 Hz frequency, measure through the oscilloscope and the 250 Hz low-pass filter the residual LF signal present on the + 12 V, + 6 V and - 12 V voltages delivered by socket (S01).</p>	<p>$P < 40 \text{ VA}$</p> <p>Residual signal : $< 3 \text{ mVp-p}$</p>
<p>4</p> <p>Frequencymeter</p>	<p>OUTPUT FREQUENCY</p> <p>a) Local mode :</p> <p>The frequencymeter and the 3100B synthesizer being driven by the same 10 MHz reference frequency, check through the frequencymeter that the frequency delivered by connector (J1) is that dialled on switches (K1).</p> <p>b) Remote mode :</p> <p>The frequencymeter and the 3100B synthesizer being driven by the same reference, check through the frequencymeter that the frequency delivered by connector (J1) is that programmed on connector (S02).</p>	
<p>5</p> <p>Multimeter RF Voltmeter Oscilloscope</p>	<p>OUTPUT LEVEL</p> <p>a) DC content</p> <p>Dial on switches (K1) a 10 kHz frequency and select on channels A and B a sine wave of e.m.f. calibrated at 7 Vpeak and 50 Ω output impedance.</p>	

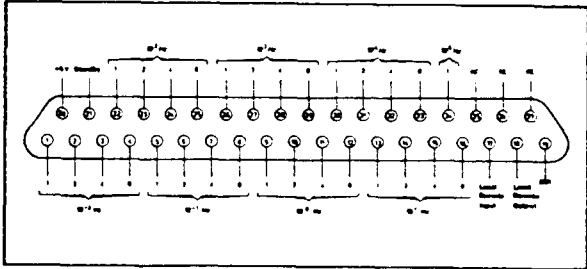

Figure VII-3 CONNECTOR (S02)

N° d'ESSAI appareils utilisés	CONDITIONS	SANCTIONS
	<p>Check with the multimeter that the DC content of the sine wave delivered by connectors (J1) and (J2) does not exceed 100 mV. In the opposite case, operate potentiometers P3 (channel A) and P2 (channel B) of the Output Mixer.</p> <p>b) Sine wave calibration</p> <p>Dial a 10 kHz frequency and select on channels A and B a sine wave of e.m.f. calibrated at 7 Vpeak and 50 Ω output impedance.</p> <p>Measure through the RF voltmeter the level of the signal delivered by connectors (J1) and (J2) on a 50 Ω load. The calibration of this level is performed through potentiometer P1 of the Output Mixer.</p> <p>c) Square Wave calibration</p> <p>Dial a 10 kHz frequency and select on channel A an e.m.f. calibrated at 7 V peak and a 50 Ω output impedance.</p> <p>Through the oscilloscope, successively measure the amplitude of the positive, negative and symmetrical square wave delivered by connector (J1) on a 50 Ω load.</p> <p>Measure also the electromotive force of the TTL square wave delivered by connector (J1).</p> <p>d) Duty cycle of square waves :</p> <p>Measure through the oscilloscope the duty cycle of the different square waves delivered by connector (J1).</p>	<p>DC content : < 100 mV</p> <p>Calibrated level : 2.5 Vrms/50 Ω \pm 100 mVrms</p> <p>Positive or negative square wave : 3.5 Vp-p/50 Ω \pm 5 %</p> <p>TTL square wave : 7 Vp-p/50 Ω \pm 5 %</p> <p>TTL square wave : 4.2 Vp-p e.m.f. + 5 %</p> <p>Duty cycle : 50 % \pm 2 %</p>
6 RF Voltmeter	<p>AMPLITUDE/FREQUENCY RESPONSE</p> <p>Select on channels A and B a sine wave of e.m.f. calibrated at 7 Vpeak and 50 Ω impedance.</p> <p>Match the (J1) and (J2) outputs with a 50 Ω load and measure through the voltmeter the output level variations with regard to the level delivered at 10 kHz.</p>	<p>Amplitude/frequency response : \pm 3 %</p>
7 RF Voltmeter	<p>ATTENUATOR CONTROL</p> <p>Dial a 199.999 kHz frequency on switches (K1) and select on channel A of the synthesizer a sine wave of e.m.f. calibrated at 7 Vpeak and 50 Ω impedance.</p>	

N° d'ESSAI appareils utilisés	CONDITIONS	SANCTIONS
<p>8</p> <p>RF Voltmeter</p>	<p>Measure with the voltmeter the level of the signal delivered by connector (J1) on a 50 Ω load when the attenuation selected by switch (K8) varies from 0 dB to 70 dB.</p> <p>MASTER OSCILLATOR OUTPUT</p> <p>Switch (K10) being on the "External" position, measure through the voltmeter the level of the 10 MHz signal delivered by connector (J5) on a 50 Ω load.</p>	<p>Signal attenuation :</p> <p>10 dB ± 0.5 dB 20 dB ± 1 dB 30 dB ± 1.5 dB 40 dB ± 2 dB 50 dB ± 2.5 dB 60 dB ± 3 dB 70 dB ± 3.5 dB</p> <p>Level : 100 mVrms/50 Ω</p>
<p>9</p> <p>Frequencymeter RF Voltmeter Attenuator</p>	<p>EXTERNAL REFERENCE DRIVING</p> <p>Set switch (K10) on "External" and drive the 3100B synthesizer by applying to connector (J5) the 10 MHz reference issued from the frequencymeter, as shown in figure VII-4.</p> <div data-bbox="454 1064 1037 1489" data-label="Diagram"> </div> <p>Figure VII-4 EXTERNAL REFERENCE DRIVING</p> <p>Through the attenuator, reduce the level of the signal applied to connector (J5) until the 3100B synthesizer ceases operating properly.</p> <p>Increase this level again and measure through the voltmeter the minimal level permitting a correct functioning of the instrument.</p>	<p>Minimal level : 50 mVrms/50 Ω</p>

N° d'ESSAI appareils utilisés	CONDITIONS	SANCTIONS
<p>10</p> <p>Frequency standard Frequency error Multiplier</p>	<p>MASTER OSCILLATOR STABILITY</p> <p>Through the error multiplier, measure the $\Delta F/F$ relative difference between the 10 MHz frequency available on connector (J5) and the reference delivered by the Frequency Standard.</p> <p>The synthesizer remaining under power, measure the $\Delta F'/F$ relative difference between these two frequencies after 24 hours'continuous operation.</p>	$\left \frac{\Delta F'}{F} - \frac{\Delta F}{F} \right < 5 \cdot 10^{-7}$ <p>after 8 hours'continuous operation.</p>
<p>11</p> <p>Spectrum analyzer (panoramic)</p>	<p>HARMONIC AND NON-HARMONIC CONTENT</p> <p>Select on channels A and B a sine wave of e.m.f. calibrated at 7 Vpeak and 50 Ω impedance.</p> <p>The (J1) and (J2) outputs being loaded by a 50 Ω impedance, measure through the spectrum analyzer the harmonic and non-harmonic components of the output signal of channels A and B for different frequencies.</p>	<p>Harmonic signals : < - 50 dB</p> <p>Non-harmonic signals : < - 70 dB</p>
<p>12</p> <p>Spectrum analyzer (high resolution) X-Y recorder</p>	<p>PHASE NOISE</p> <p>Dial a 100 kHz frequency on Switches (K1) and select on channel A or B a sine wave of 2 Vpeak e.m.f. and 50 Ω impedance.</p> <p>Through the spectrum analyzer and the X-Y recorder, note the phase noise in a 1 Hz band at 100 Hz, 1 kHz and 10 kHz from carrier.</p>	<p>Phase noise in a 1 Hz band :</p> <ul style="list-style-type: none"> - 110 dB at 100 Hz - 115 dB at 1 kHz - 125 dB at 10 kHz
<p>13</p> <p>Phasemeter</p>	<p>PHASE-SHIFT</p> <p>Select on channels A and B a sine wave of e.m.f. calibrated at 7 Vpeak and 50 Ω impedance.</p> <p>Connect the phasemeter on the (J1) and (J2) outputs through two coaxial cables of same length terminated by a 50 Ω load.</p> <p>Measure the phase-shift between these two outputs for different values of the synthesized frequency.</p>	<p>Channel A/Channel B phase-shift : $90^\circ \pm 0.5^\circ$</p>

N° d' ESSAI appareils utilisés	CONDITIONS	SANCTIONS
<p>1</p> <p>RF Voltmeter Milliwattmeter</p>	<p style="text-align: center; border: 1px solid black; padding: 5px;">OPTION 3111B</p> <p>ATTENUATION CONTROL</p> <p>Dial on the 3100B synthesizer a 199.999 kHz frequency and select on channel A a sine wave of 50 Ω output impedance.</p> <p>Interlink connector (J1) of the synthesizer with connector (J11) of option 3111B, and connect the RF voltmeter or the milliwattmeter on connector (J12) while ensuring the impedance matching.</p> <p>For different values of the attenuation, measure the deviation between the attenuation really brought to the signal of the synthesizer and the value set on switches (K11), (K12) and (K13).</p>	<p>Attenuation accuracy :</p> <ul style="list-style-type: none"> ● 0.1 dB steps : ± 0.05 dB ● 1 dB steps : ± 0.1 dB ● 10 dB steps : ± 0.2 dB
<p>2</p> <p>RF Voltmeter Milliwattmeter</p>	<p>CONTROL OF PROGRAMMING</p> <p>Switch (K13) being set in "Remote" position, check the concordance between the attenuation brought by option 3111B and the value programmed on connector (S011).</p> <div style="text-align: center; border: 1px solid black; padding: 10px; margin: 10px 0;"> </div>	
<p>3</p> <p>Phasemeter</p>	<p>PHASE-SHIFT INTRODUCED BY THE ATTENUATOR</p> <p>Dial on the synthesizer a 199.999 kHz frequency and select on channel A a sine wave of e.m.f. calibrated at 7 V_{peak} and of 50 Ω impedance.</p> <p>Interlink connector (J1) with connector (J11) with a coaxial cable as short as possible and connect the phase-meter to the (J11) and (J12) outputs through two coaxial cables of the same length. The phase-shift introduced by the attenuator must be less than $\pm 2^\circ$.</p>	<p>Maximum phase-shift at 200 kHz : $\pm 2^\circ$</p>

N° d' ESSAI appareils utilisés	CONDITIONS	SANCTIONS
<p>1</p> <p>RF voltmeter Multimeter</p>	<p style="text-align: center; border: 1px solid black; padding: 5px;">OPTION 3112B</p> <p>OUTPUT LEVEL</p> <p>Dial on the 3100B synthesizer a 10 kHz frequency and select on the 3112B option an e.m.f. calibrated at 7 V_{peak} and a 50 Ω output impedance.</p> <p>a) DC content :</p> <p>Through the multimeter, check that the DC content of the signal delivered by connector (J21) does not exceed ± 100 mV.</p> <p>b) Calibration :</p> <p>Measure through the voltmeter the level of the signal delivered at a 50 Ω load by connector (J21). The calibration of this level is performed through potentiometer P4 of the Output Circuit (plate VI-18).</p>	<p>DC content : < 100 mV</p> <p>Calibrated level : 2.5 V_{rms}/50 Ω ± 5 %</p>
<p>2</p> <p>RF Voltmeter</p>	<p>AMPLITUDE/FREQUENCY RESPONSE</p> <p>Select on the 3112B option an e.m.f. calibrated at 7 V_{peak} and a 50 Ω output impedance.</p> <p>The (J21) output being loaded by a 50 Ω impedance, measure through the voltmeter the output level variations compared with the level delivered at 10 kHz.</p>	<p>Amplitude/Frequency response : ± 3 %</p>
<p>3</p> <p>Phasemeter</p>	<p>PHASE-SHIFT</p> <p>Select on channel A of the 3100B and on option 3112B a sine wave of e.m.f. calibrated at 7 V_{peak} and of 50 Ω output impedance.</p> <p>Connect the phasemeter to the (J1) and (J21) outputs through two coaxial cables of same length terminated by a 50 Ω load.</p> <p>a) Linearity</p> <p>Dial a 1 kHz frequency on the synthesizer. Vary the phase-shift from 0° to 359.9° and measure the deviation between the value displayed by switches (K21) and the phase-shift indicated by the phasemeter.</p> <p>If this deviation exceeds ± 1°, successively operate potentiometers P1 (general adjustment), P3(0° and 180° adjustment), P5 (90° and 270° adjustment) and P4 (45°, 135°, 225° and 315° adjustment) of the Generation sin φ/cos φ subassembly (plate VI-17).</p>	<p>Linearity : ± 1°</p>

N° d'ESSAI appareils utilisés	CONDITIONS	SANCTIONS
----------------------------------	------------	-----------

Figure VII-6 shows the deviation curve as a function of the phase-shift when the instrument is correctly adjusted.

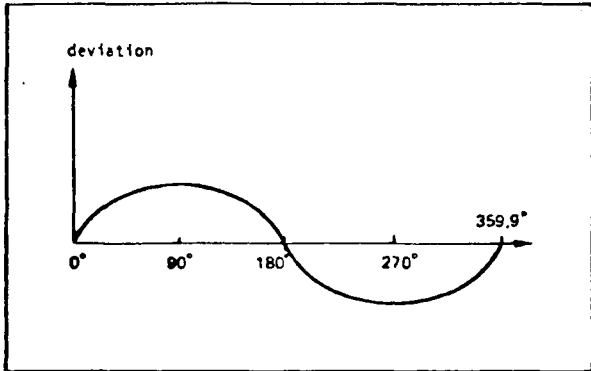

Figure VII-6 PHASE-SHIFT LINEARITY

Then dial a 199 kHz frequency on the synthesizer and plot the deviation curve as a function of the phase-shift. If this deviation exceeds $\pm 1^\circ$, operate capacitor C2 of the Output Circuit (plate VI-18).

b) Phase/frequency response

Dial 45° on switches (K21) and measure with the phasemeter the phase-shift variation as a function of the synthesized frequency.

Phase/frequency response : $\pm 1^\circ$

4
Phasemeter

CONTROL OF PROGRAMMING

Select on channel A of the 3100B and on option 3112B a sine wave of e.m.f calibrated at 7 Vpeak and of 50 Ω output impedance.

Connect the phasemeter to the (J1) and (J21) outputs through two coaxial cables of same length terminated by a 50 Ω load.

The "Local/Remote" key (K24) being pressed, dial on the 3100B a 10 kHz frequency and check the concordance between the phase-shift programmed on connector (S012) and the value measured by the phasemeter.

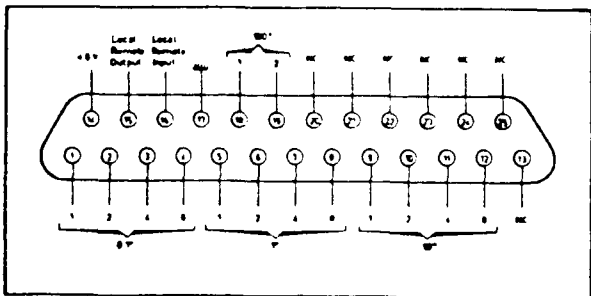
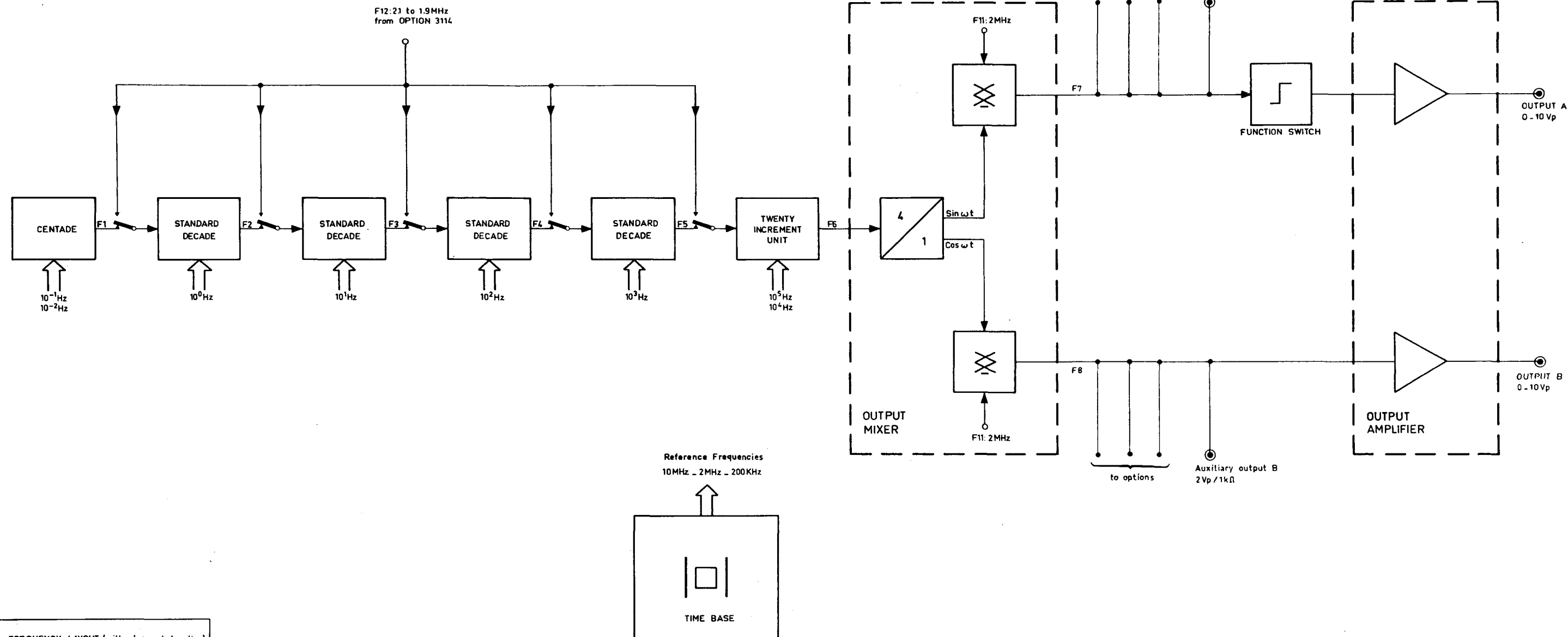

Figure VII-7 CONNECTOR (S012)

N° d'ESSAI appareils utilisés	CONDITIONS	SANCTIONS
<p>5</p> <p>RF Voltmeter</p>	<p>AMPLITUDE/PHASE RESPONSE</p> <p>Dial on the 3100B a 199 kHz frequency and select on option 3112B an e.m.f. calibrated at 7 V_{peak} and a 50 Ω impedance.</p> <p>The (J21) output being matched by a 50 Ω load, measure through the voltmeter the output level variations when the phase-shift varies from 0° to 359.9°.</p>	<p>Amplitude/phase response : ± 0.25 dB</p>
<p>6</p> <p>Spectrum analyzer (panoramic)</p>	<p>HARMONIC AND NON-HARMONIC CONTENT</p> <p>Select on option 3112B an e.m.f. calibrated at 7 V_{peak} and a 50 Ω impedance.</p> <p>The (J21) output being matched by a 50 Ω load, measure through the spectrum analyzer the harmonic and non-harmonic components of the output signal for different frequencies.</p>	<p>Harmonic signals : < - 45 dB</p> <p>Non-harmonic signals : < - 65 dB</p>
<p>7</p> <p>Spectrum analyzer (high resolution)</p> <p>X-Y Recorder</p>	<p>PHASE NOISE</p> <p>Dial a 100 kHz frequency on the 3100B and select on option 3112B a sine wave of 2 V_{peak} e.m.f. and 50 Ω impedance.</p> <p>Through the spectrum analyzer and the X-Y recorder, note the phase noise in a 1 Hz band at 100 Hz, 1 kHz and 10 kHz from carrier.</p>	<p>Phase noise in a 1 Hz band:</p> <ul style="list-style-type: none"> - 110 dB at 100 Hz - 115 dB at 1 kHz - 115 dB at 10 kHz

N° d'ESSAI appareils utilisés	CONDITIONS	SANCTIONS
	<div style="border: 1px solid black; padding: 5px; width: fit-content; margin: 0 auto;">OPTION 3114B</div>	
<p style="text-align: center;">1</p> <p>Oscilloscope</p>	<p style="text-align: center;">SWEEP AMPLITUDE</p> <p>Set switch (K45) on 0.01 s and select the sweep by symmetrical triangles through keyboard (K41).</p> <p>Check with the oscilloscope the centering with regard to 0 V of the sweep triangles delivered by (J41). The amplitude of these triangles must be $10 \text{ Vp-p} \pm 10 \%$.</p>	<p style="text-align: center;">Amplitude : $10 \text{ Vp-p} \pm 10 \%$</p>
<p style="text-align: center;">2</p> <p>Oscilloscope</p>	<p style="text-align: center;">START/STOP CONTROL</p> <p>Set switch (K45) on 10 s and select the sawtooth sweep through keyboard (K41).</p> <p>a) START control :</p> <p style="padding-left: 20px;">With the oscilloscope, check that grounding socket (J46) or pressing "Start" key (K42) starts the sawtooth delivered by connector (J41).</p> <p>b) STOP control :</p> <p style="padding-left: 20px;">Check that grounding socket (J47) or pressing "Stop" key (K43) brings back to - 5 V the sawtooth delivered by (J41).</p> <p>c) TRACE output :</p> <p style="padding-left: 20px;">With the oscilloscope, check that "Trace" output (J45) delivers about 0 V when the sawtooth rises and about + 12 V when it returns to - 5 V.</p>	
<p style="text-align: center;">3</p> <p>Oscilloscope chronometer</p>	<p style="text-align: center;">SWEEP DURATION</p> <p>Select the sweep by symmetrical triangles and measure with the oscilloscope the half-period of these triangles for a sweep duration between 0.01 s and 1 s.</p> <p>Then, select the sawtooth sweep and measure with the chronometer the duration of this sawtooth for a sweep duration between 3 s and 300 s.</p> <p>In both cases, the difference between the indication of switch (K45) and the duration measured must be less than $\pm 20 \%$.</p>	<p style="text-align: center;">Accuracy : $\pm 20 \%$</p>

N° d'ESSAI appareils utilisés	CONDITIONS	SANCTIONS
<p>4 Frequencymeter</p>	<p>INTERPOLATION ACCURACY</p> <p>Dial a 0 Hz frequency on the 3100B and select a ± 10 kHz interpolation range through keyboard (K44).</p> <p>Center the interpolation oscillator through potentiometer (P43), then check the accuracy of the graduations on graduated scale (DS41) for different positions of potentiometer (P41).</p> <p>This measurement can also be achieved by connecting the frequencymeter to the 5 MHz ± 1 MHz output.</p>	<p>Accuracy : $\pm 5 \%$</p>
<p>5 RF Voltmeter</p>	<p>5 MHz ± 1 MHz OUTPUT LEVEL</p> <p>Connect the voltmeter to connector (J42) loaded with a 50 Ω impedance and measure the level of the 5 MHz ± 1 MHz signal when the frequency varies from 4 MHz to 6 MHz.</p>	<p>Level : 200 mVrms/50 Ω ± 100 mVrms</p>
<p>6 Frequencymeter Source</p>	<p>EXTERNAL SWEEP</p> <p>Select the external sweep through keyboard (K41) and apply a - 5 V to + 5 V DC voltage to connector (J41).</p> <p>Make this voltage vary by 0.5 V steps and check through the frequencymeter that the frequency of the signal delivered by (J42) varies from 4 MHz to 6 MHz in 100 kHz steps.</p>	



FREQUENCY LAYOUT (without search function)

F1:	2MHz to 1.901MHz
F2:	2MHz to 1.9001MHz
F3:	2MHz to 1.90001 MHz
F4:	2MHz to 1.900001MHz
F5:	2MHz to 1.9000001MHz
F6:	8MHz to 7.20000004MHz
F7:	0.01Hz to 199.99999 kHz
F8:	0.01Hz to 199.99999kHz

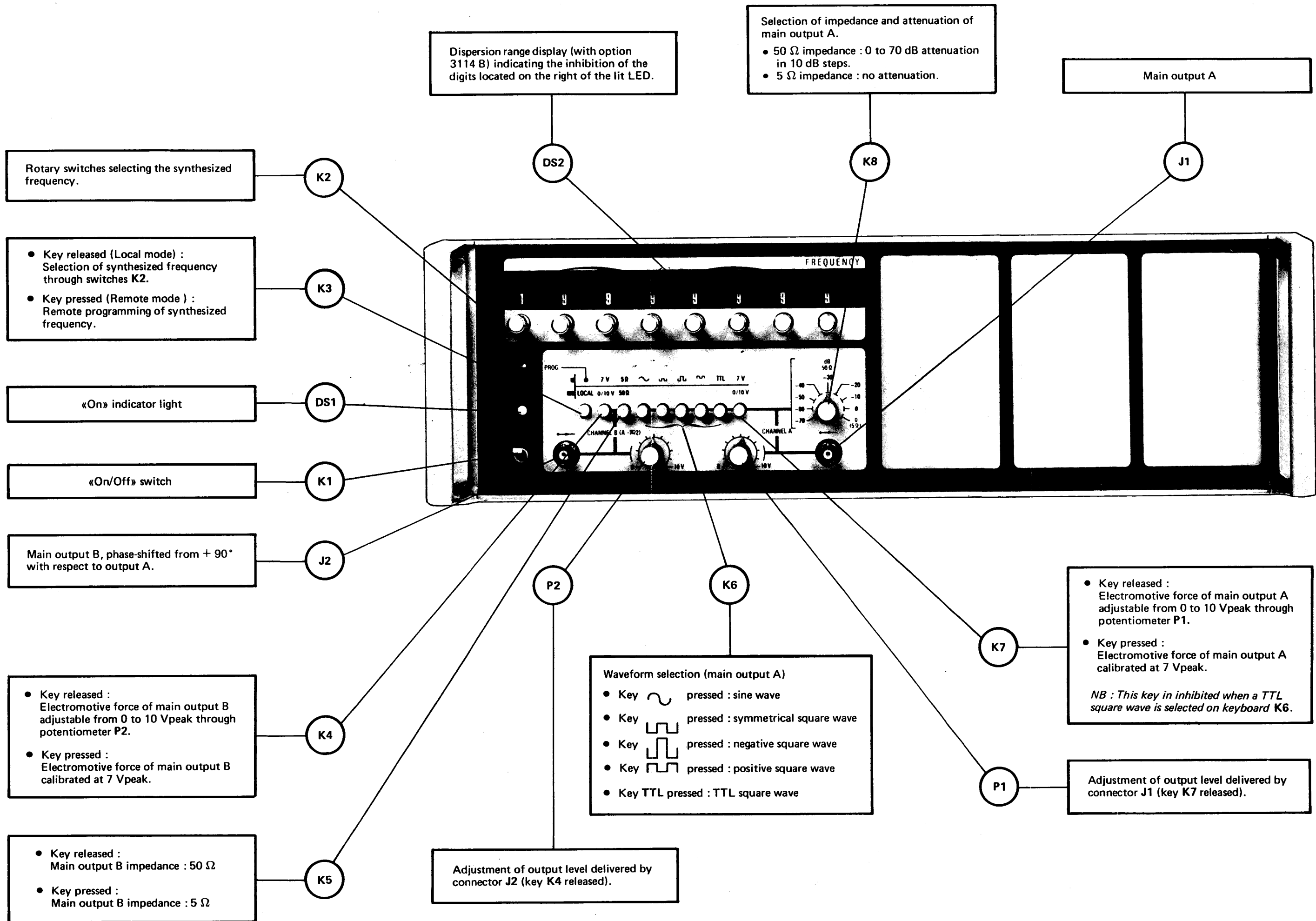

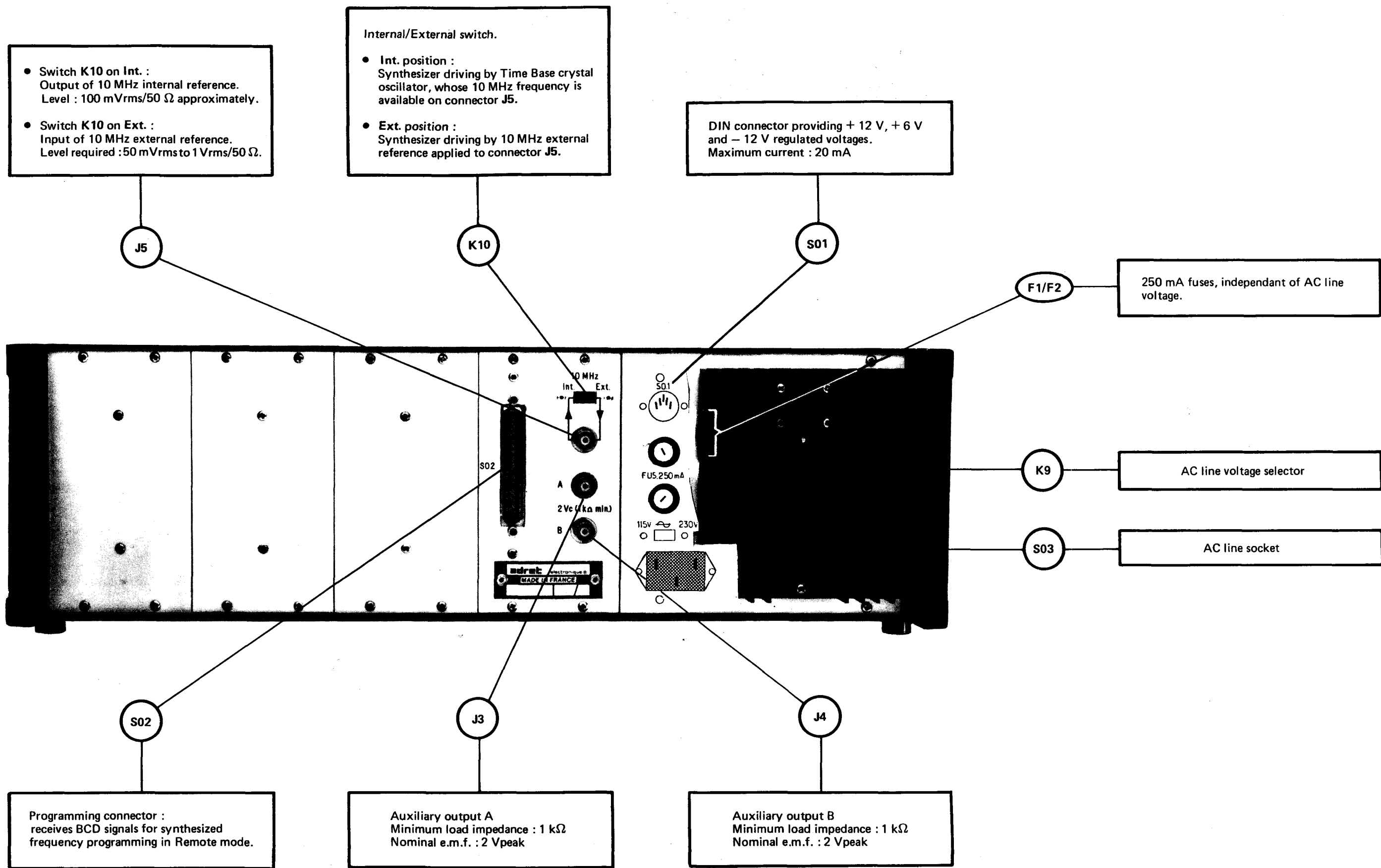

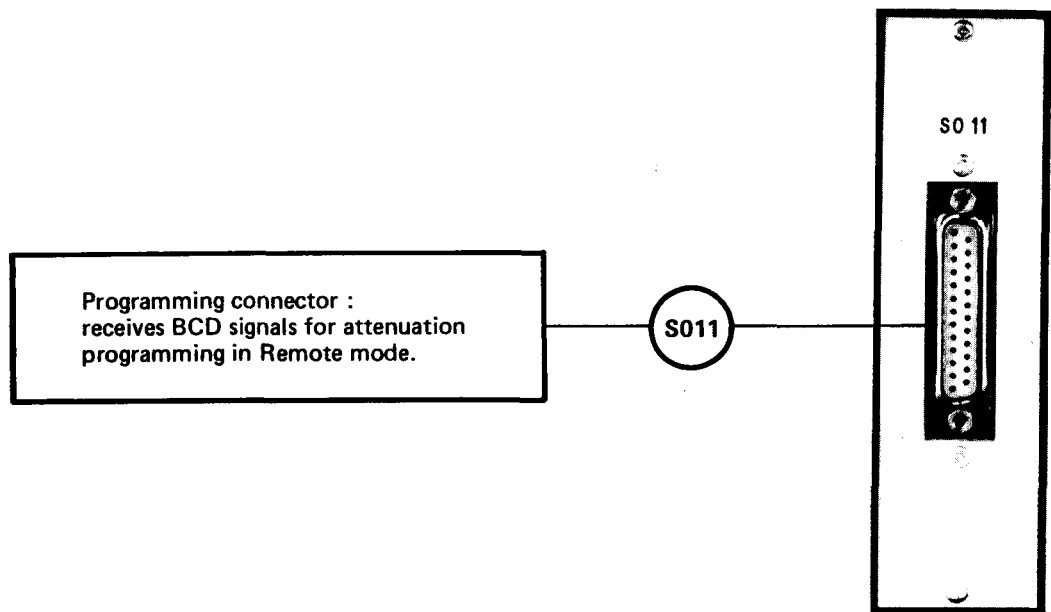
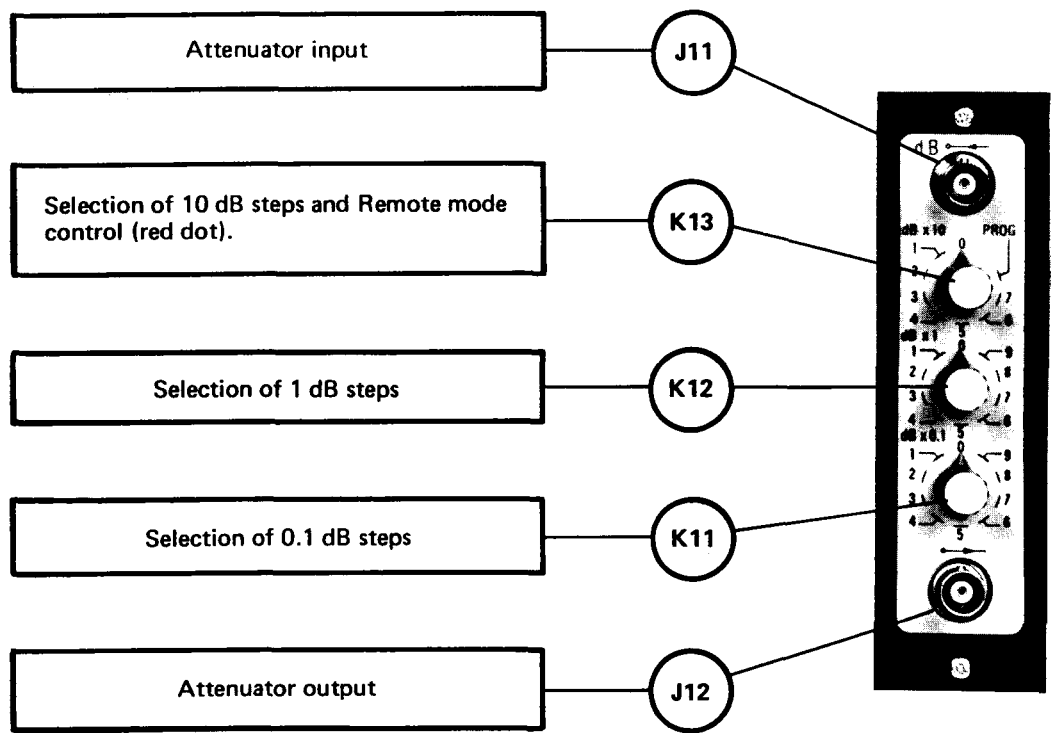

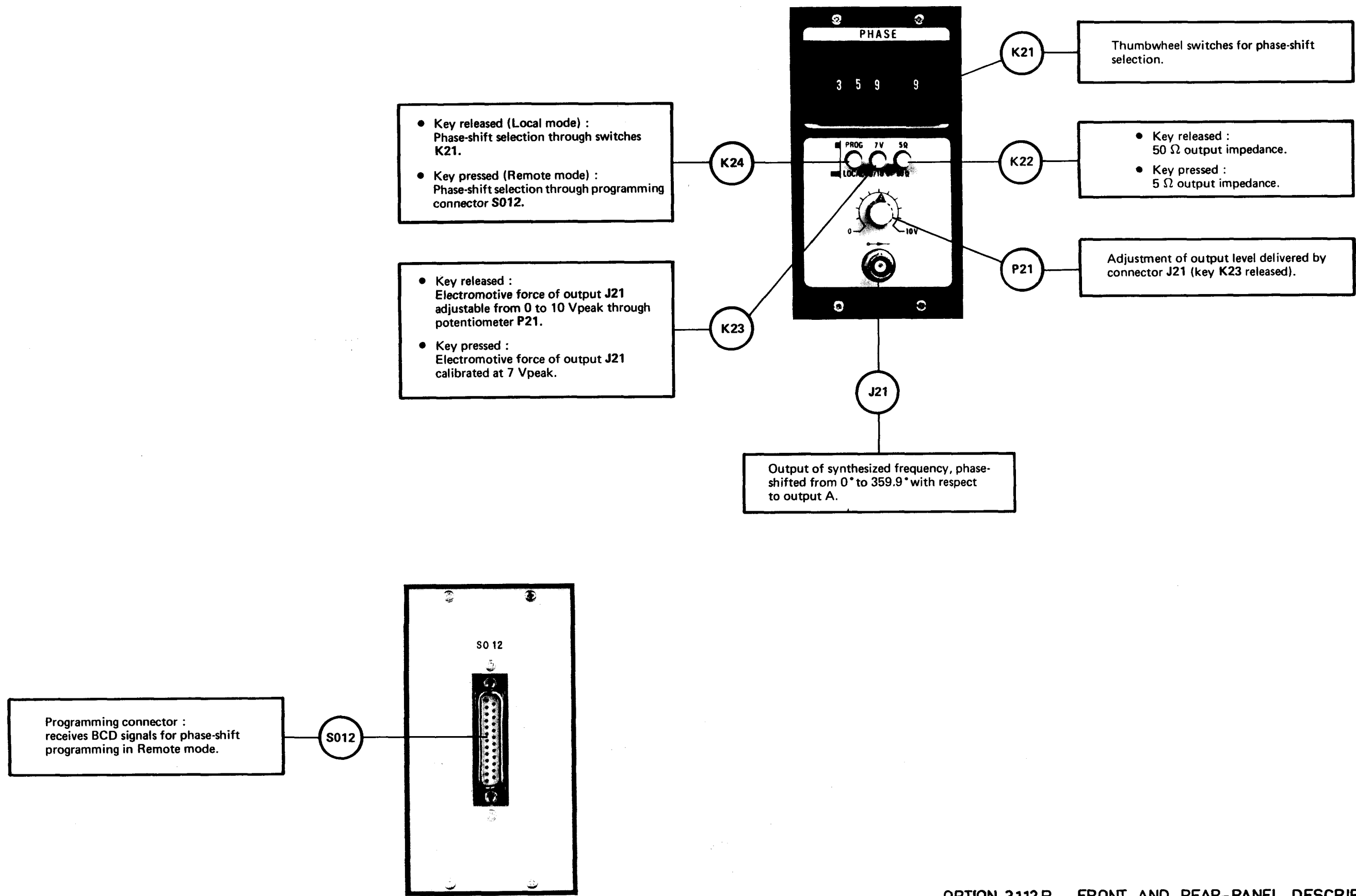

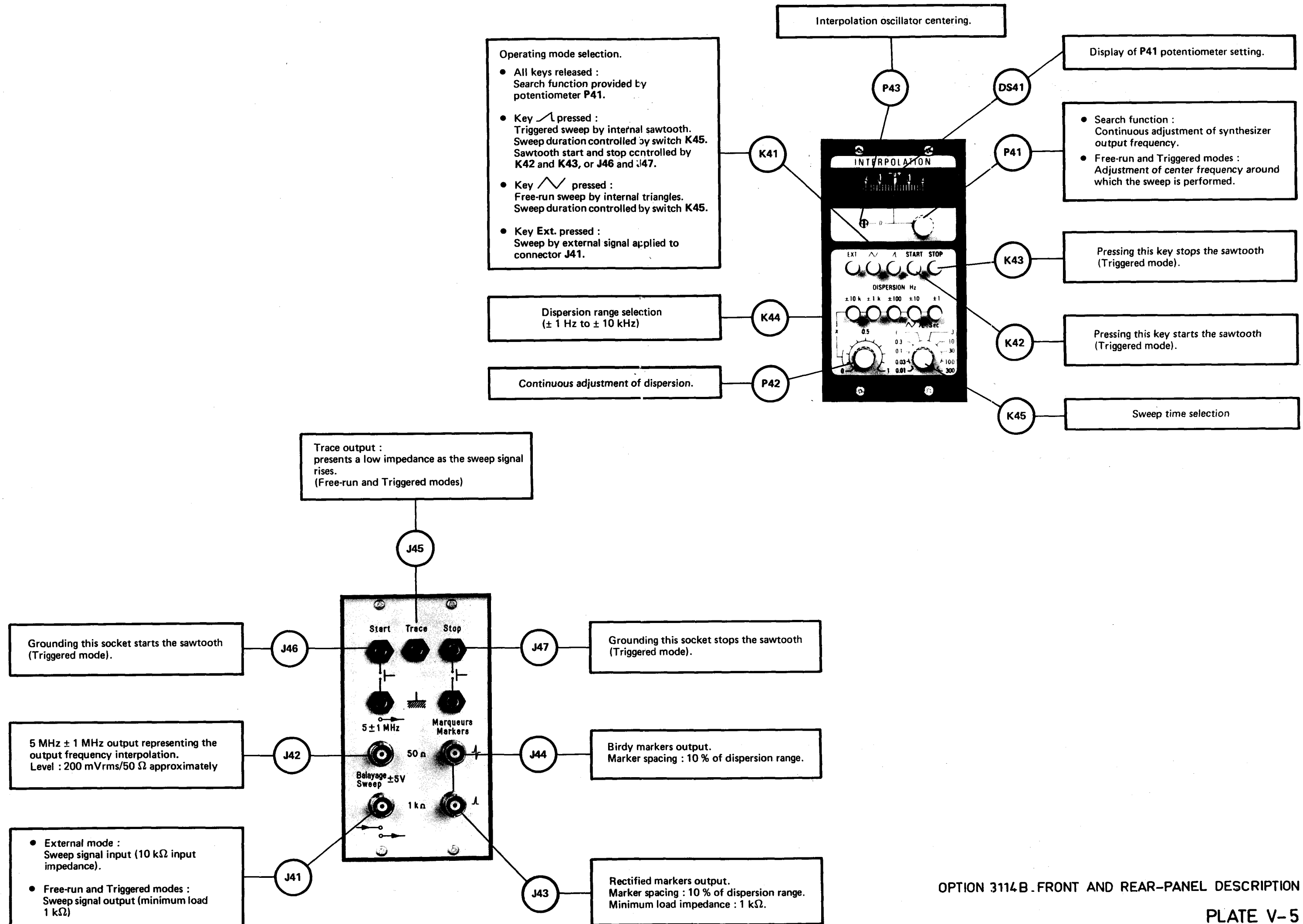

BOTTOM VIEW

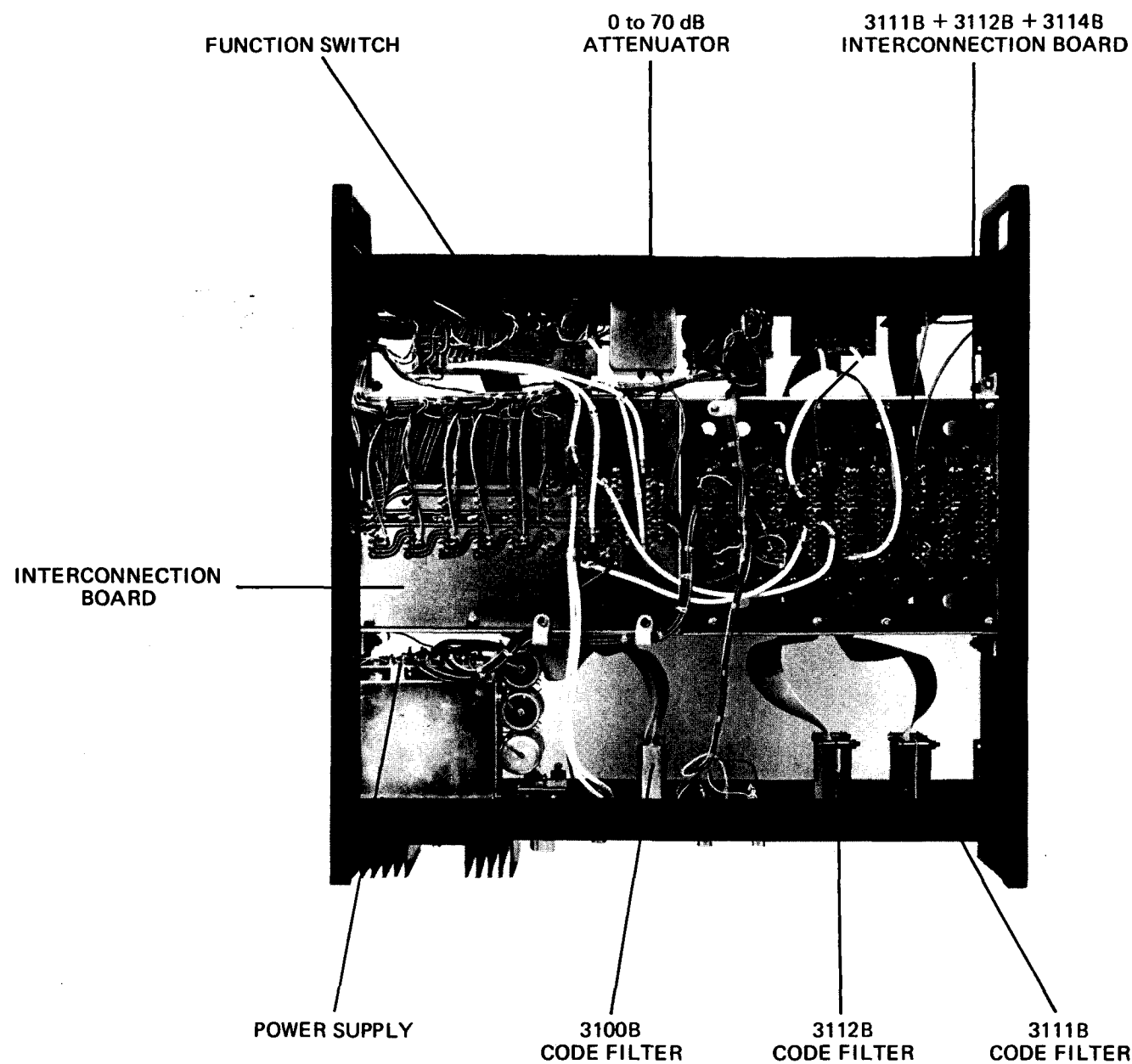

TOP VIEW

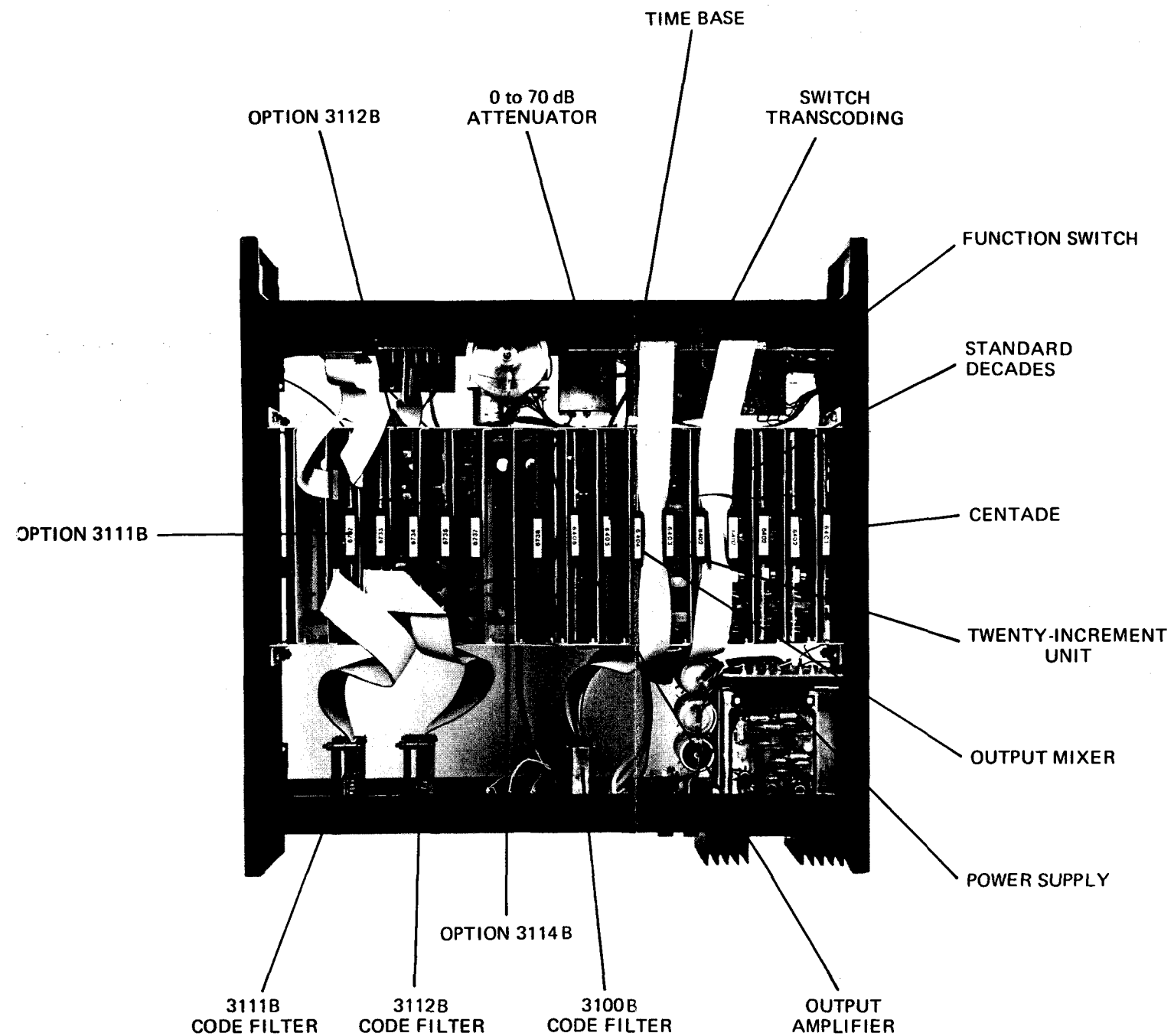

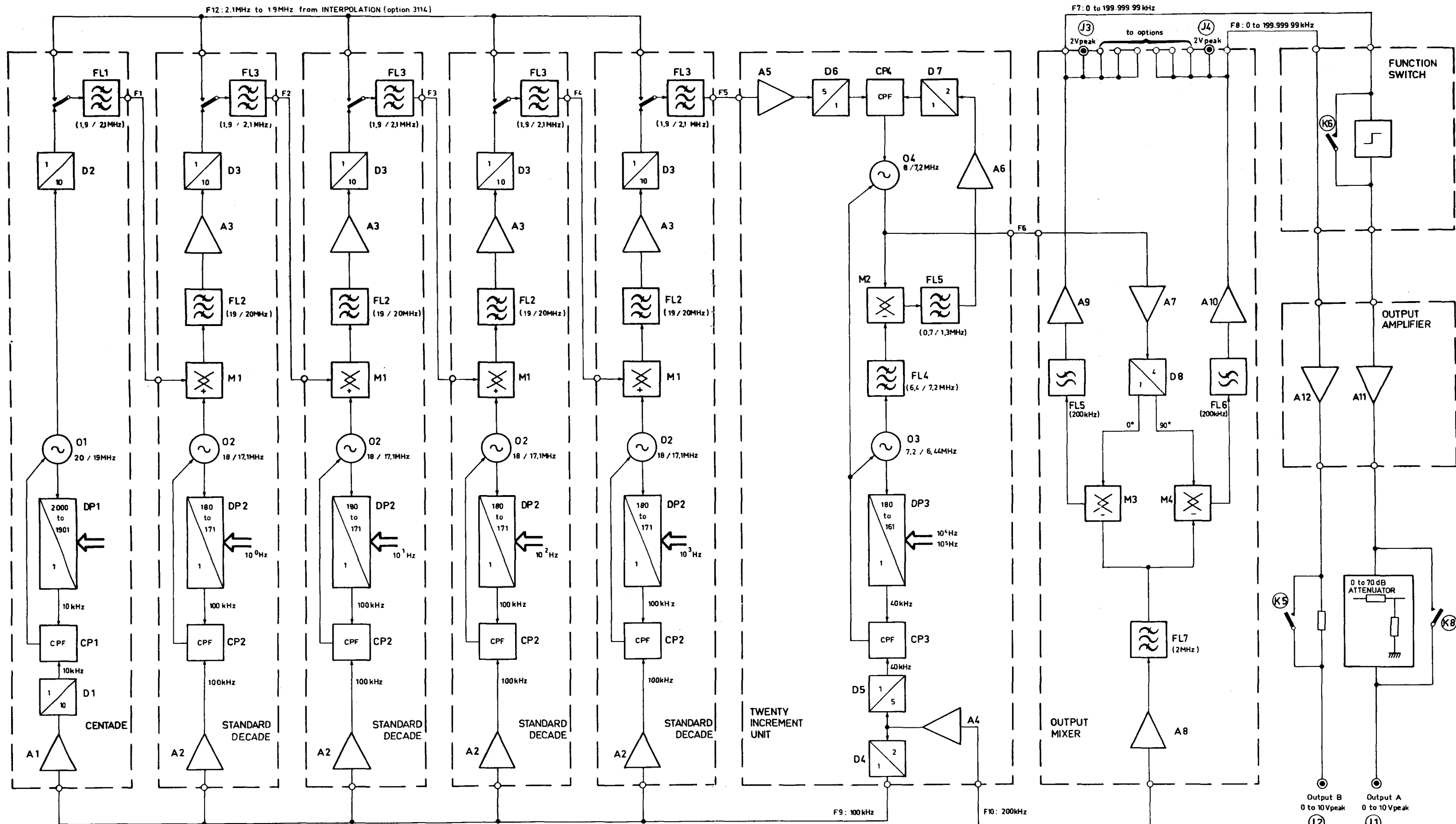

FREQUENCY LAYOUT (WITHOUT SEARCH FUNCTION)

F1: 2MHz to 1,901MHz
 F2: 2MHz to 1,9001MHz
 F3: 2MHz to 1,900 01MHz
 F4: 2 MHz to 1,900 001MHz
 F5: 2 MHz to 1,900 000 1MHz
 F6: 0 MHz to 7,200 000 04MHz
 F7: 0.01Hz to 199,999 99 kHz
 F8: 0.01Hz to 199,999 99 kHz

